

smiths



Fluid Management Systems for Industrial Applications

TITEFLEX[®]

Titeflex's proven reputation and successful track record of innovation and quality can be traced to its aerospace roots, which reach back to the earliest days of the space age. Even then, Titeflex was a conscientious developer of products designed to protect our environment. Creating new products and adapting existing materials and quality programs from this market have contributed significantly to our record of success.

Among the markets which we serve are Chemical, Petro-chemical, Pulp and Paper, Heavy Equipment, Refrigeration, Petroleum Equipment, and the rapidly expanding Compressed Natural Gas (CNG) industry.

Applications centering on the most demanding fluid transfer requirements, whether the media be corrosive, caustic or food grade, under extreme pressure, temperature and flexing conditions, are routinely handled and serviced by Titeflex PTFE. Titeflex's history and experience in stringent and demanding hose requirements underscores the background and technical training of our applications engineers. Using our decades of experience and core technology we are able to assimilate some of the most difficult and demanding applications required by modern industry – and accomplish these challenges with a keen sense of protecting and preserving our environment.

Our constant dedication to quality and innovation is reflected in the exceptional level of customer satisfaction which we have attained. All employees are dedicated to achieving total customer satisfaction and our professional customer service teams provide an ideal blending of commercial and technical knowledge and experience. Titeflex is the only company to provide PTFE hose to industrial customers manufactured to the exacting AS-9100 aerospace standard.

In today's world we recognize the critical need to eliminate waste and practice the ultimate safety measures in the use of all materials. Wherever feasible we recycle all materials, from paper and cardboard to chemicals and solvents. Our objective is to minimize waste and eliminate the discharge of pollutants to our air and water. We strive continuously for increasingly efficient production methods and the conservation of materials. We are constantly pursuing additional ways through which we can contribute measurably to the development of sustainable products.

Titeflex's extensive network of stocking and fabrication distributors provides a strong value-added benefit to end users of Titeflex products. Fast turnaround, high value, dependable service and superior quality are key elements of Titeflex's history of success.

	Page
SMOOTH BORE PTFE MEDIUM PRESSURE HOSE & FITTINGS	
R115/R105 HOSE AND R122/R144 CONDUCTIVE HOSE	4
R115/R122 HOSE AND R105/R144 HOSE FITTINGS	6
R115/R122 HOSE FITTINGS	7
SMOOTH BORE PTFE HIGH PRESSURE HOSES & FITTINGS	
UNI-BRAID® R165 HOSE	8
UNI-BRAID® HOSE FITTINGS	9
SMOOTH BORE PTFE HIGH PERFORMANCE HOSE & FITTINGS	
R154 HOSE	10
R154 HOSE FITTINGS	11
CONVOLUTED PTFE HOSE & FITTINGS	
R272/R276 HOSE	12
R285/R287 FULL VACUUM RATED HOSE	13
R272/R276 AND R285/R287 HOSE FITTINGS	14
R272/R276 AND R285/R287 HOSE FITTINGS	15
SPECIALTY HOSE	
CHLORINE/BROMINE HOSE	16
S818XX PTFE CHLORINE/BROMINE HOSE & HOSE OPTIONS	17
CHEMICAL RESISTANCE DATA	18
TEMPERATURE/OPERATING PRESSURE	22
CRIMP AND SWAGE DIMENSIONS	23
PERFORMANCE CHARACTERISTICS	24
HOW TO SPECIFY ACCESSORIES	25
WARRANTY AND DISCLAIMER	26



R115/R105 HOSE



R122/R144 CONDUCTIVE HOSE

APPLICATIONS:

- Compressed gas
- Fuel and lubricant handling
- Steam transfer
- Hydraulic systems

TEMPERATURE RANGE:

- -65°F to 400°F (-54°C to 204°C) for continuous service
- -100°F to 500°F (-73°C to 260°C) for intermittent service

Consult factory for temperature adjusted pressure rating

STANDARDS:

- Meets or exceeds requirements of SAE 100R14
- PTFE meets FDA 21 CFR 177.1550

HOSE CONSTRUCTION:

- Innercore vertically extruded to maintain highest quality of concentricity
- Manufactured from fine powder PTFE
- 304 stainless steel wire braid reinforcement
- A precisely controlled amount of carbon black added to the PTFE innercore provides a continuous conductive path to the metal end filling, to dissipate static electricity in fuel, steam, or high flow-rate applications

VACUUM SERVICE:

- Sizes -4 through -10 are rated for full vacuum
- Larger sizes -12 and above can be reinforced with an internal support spring for full vacuum service

Applications centering on the transfer of fluids or gases under demanding conditions in harsh environments are opportunities for the user to realize the value of Titeflex.

Innovative PTFE technology by Titeflex satisfies the demanding aerospace, automotive, and industrial applications.

The driving force is Titeflex commitment to safety, quality, value, and reliability.

Modern quality production and customer satisfaction make Titeflex the leading PTFE hose producer.

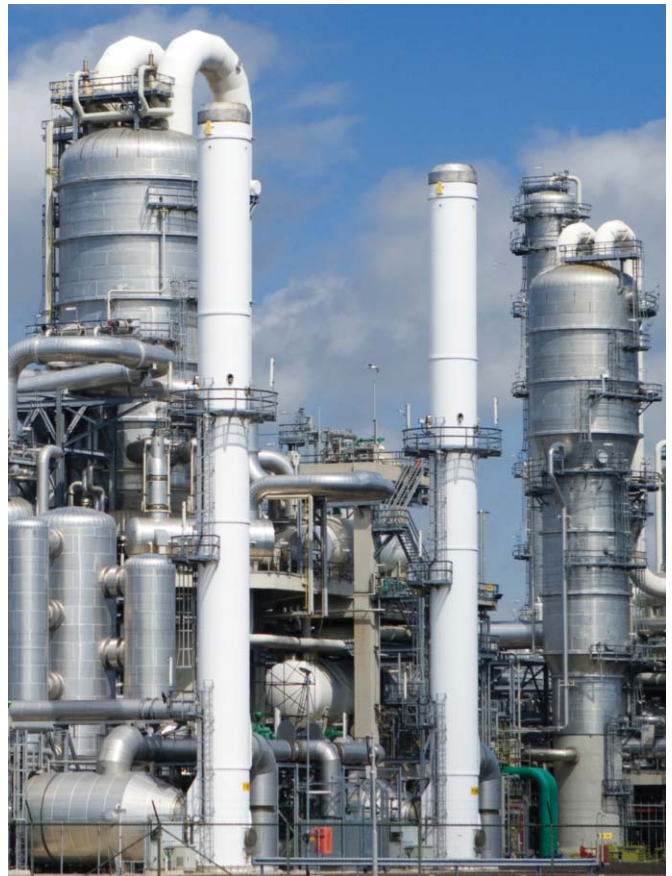

These products can be used to convey hazardous fluids, steam, and other dangerous materials which can cause personal injury or property damage if released through misuse, misapplication, or damaged. The user is responsible to analyze each application prior to specifying any product from this catalog. Due to the wide variety of operating conditions and applications, the user, through personal analysis and testing, is solely responsible for final product selection and meeting all performance, safety, and warning requirements. Careful selection, proper assembly and use of hose fittings and accessories is essential for the safe and warranted operation of the hose assembly.

R115/R105 HOSE AND R122/R144 CONDUCTIVE HOSE

SMOOTHBORE PTFE HOSE

MEDIUM PRESSURE

R115 .030 WALL HOSE/R122 CONDUCTIVE HOSE

HOSE PART NUMBER	NOMINAL SIZE	AVERAGE ID	AVERAGE ID	AVERAGE OD	OPERATING PRESSURE ROOM TEMP	BURST PRESSURE ROOM TEMP	MAXIMUM CONTINUOUS LENGTH	MINIMUM BEND	HOSE WEIGHT
	in	in	mm	in	psi	psi	ft	in	lb/ft
R115/R122-3	3/16	.139	3.5	.234	3,000	12,000	200	2.00	.048
R115/R122-4	1/4	.188	4.8	.312	3,000	12,000	200	2.00	.058
R115/R122-5	5/16	.250	6.4	.375	3,000	12,000	250	3.00	.078
R115/R122-6	3/8	.313	8.0	.445	2,500	10,000	150	4.00	.098
R115/R122-6T*	3/8	.384	9.8	.503	2,250	9,000	150	4.50	.105
R115/R122-8	1/2	.410	10.4	.549	2,000	8,000	100	5.20	.126
R115/R122-10	5/8	.504	12.8	.648	1,500	6,000	100	6.50	.154
R115/R122-12	3/4	.636	16.2	.778	1,200	4,800	75	7.70	.190
R115/R122-12T*	3/4	.750	19.1	.886	1,100	4,400	75	8.20	.211
R115/R122-16	1	.875	22.2	1.030	1,000	4,000	60	9.00	.280
R115/R122-16T*	1	1.000	25.4	1.135	900	3,600	60	10.00	.322
R115/R122-16Z+	1	.875	22.2	1.065	1,250	5,000	60	9.00	.459
R115/R122-20	1-1/4	1.125	28.6	1.315	800	3,200	40	16.00	.369

Consult factory for temperature-adjusted ratings. *True bore. +Double braid.

R105 .040 WALL HOSE/R144 CONDUCTIVE HOSE

HOSE PART NUMBER	NOMINAL SIZE	AVERAGE ID	AVERAGE ID	AVERAGE OD	OPERATING PRESSURE ROOM TEMP	BURST PRESSURE ROOM TEMP	MAXIMUM CONTINUOUS LENGTH	MINIMUM BEND	HOSE WEIGHT
	in	in	mm	in	psi	psi	ft	in	lb/ft
R105/R144-4	1/4	.188	4.8	.323	3,000	12,000	200	2.00	.08
R105/R144-5	5/16	.250	6.4	.386	3,000	12,000	150	2.50	.09
R105/R144-6	3/8	.313	8.0	.451	2,500	10,000	150	4.00	.11
R105/R144-8	1/2	.410	10.4	.566	2,000	8,000	100	4.60	.14
R105/R144-10	5/8	.504	12.8	.665	1,500	6,000	100	5.50	.19
R105/R144-12	3/4	.636	16.1	.795	1,200	4,800	75	6.50	.23
R105/R144-16	1	.879	22.3	1.060	1,000	3,200	60	9.00	.30

WARNING: These products can be used to convey hazardous fluids, steam, and other dangerous materials which can cause personal injury or property damage if released through misuse, misapplication, or damaged. The user is responsible to analyze each application prior to specifying any product from this catalog. Due to the wide variety of operating conditions and applications, the user, through personal analysis and testing, is solely responsible for final product selection and meeting all performance, safety, and warning requirements. Careful selection, proper assembly and use of hose fittings and accessories is essential for the safe and warranted operation of the hose assembly.

MATERIALS:

- Brass
- 300 series stainless steel

FEATURES:

- Swage or crimp attachment
- For use with:
 - R115/R122 (.030 wall hose)
 - R105/R144 (.040 wall hose)
- “Back-up” hex JIC (TK2)
- Attach with TK2 tooling

Distributors may use their traditional swage tooling with quick swage fittings or use the more versatile TK2 fittings that may be swaged or crimped on both .03 wall (R115/R122) and .04 wall (R105/R144). TK2 is available in one- or two-piece versions.

**MALE PIPE**

PART NUMBER 1 PIECE FITTING	PART NUMBER 2 PIECE FITTING	SIZE IN.	THREAD	NOMINAL ID
Y54104T-xxx	Y54304T-xxx	1/4	1/8 – 27	.156
Y54104-xxx	Y54304-xxx	1/4	1/4 – 18	.156
Y54105-xxx	Y54305-xxx	5/16	1/4 – 18	.207
Y54106T-xxx	Y54306T-xxx	3/8	1/4 – 18	.277
Y54106-xxx	Y54306-xxx	3/8	3/8 – 18	.277
Y54108T-xxx	Y54308T-xxx	1/2	3/8 – 18	.358
Y54108-xxx	Y54308-xxx	1/2	1/2 – 14	.358
Y54110-xxx	Y54310-xxx	5/8	1/2 – 14	.469
Y54112-xxx	Y54312-xxx	3/4	3/4 – 14	.594
Y54116-xxx	Y54316-xxx	1	1 – 11-1/2	.812

Note the appropriate suffix:

- 93 = Brass
- 931 = Brass with QuikSwage Collar
- 95 = Stainless steel
- 951 = Stainless with QuikSwage Collar

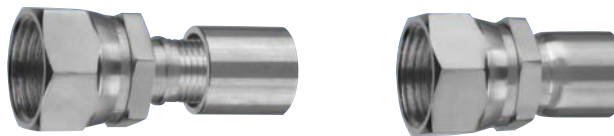
**JIC FEMALE SWIVEL WITH “BACK-UP” HEX**

PART NUMBER 1 PIECE FITTING	PART NUMBER 2 PIECE FITTING	SIZE IN.	THREAD	NOMINAL ID
Y54004-xxx	Y54204-xxx	1/4	7/16 – 20	.156
Y54005-xxx	Y54205-xxx	5/16	1/2 – 20	.207
Y54006-xxx	Y54206-xxx	3/8	9/16 – 18	.277
Y54008-xxx	Y54208-xxx	1/2	3/4 – 16	.358
Y54010-xxx	Y54210-xxx	5/8	7/8 – 14	.469
Y54012-xxx	Y54212-xxx	3/4	1-1/16 – 12	.594
Y54016-xxx	Y54216-xxx	1	1-5/16 – 12	.812

Note the appropriate suffix:

- 93 = Brass
- 931 = Brass with QuikSwage Collar
- 95 = Stainless steel
- 951 = Stainless with QuikSwage Collar



WARNING

These products can be used to convey hazardous fluids, steam, and other dangerous materials which can cause personal injury or property damage if released through misuse, misapplication, or damaged. The user is responsible to analyze each application prior to specifying any product from this catalog. Due to the wide variety of operating conditions and applications, the user, through personal analysis and testing, is solely responsible for final product selection and meeting all performance, safety, and warning requirements. Careful selection, proper assembly and use of hose fittings and accessories is essential for the safe and warranted operation of the hose assembly.

COMPRESSION TUBE END



NOTE: Compression tube end inserts are type 316SS

STAINLESS STEEL PART NUMBER	SIZE IN.	THREAD	NOMINAL ID IN.
Y53604-1	1/4	1/4" O.D.Tube	.156
Y53606-1	3/8	3/8" O.D.Tube	.277
Y53608-1	1/2	1/2" O.D.Tube	.358
Y53612-1	3/4	3/4" O.D.Tube	.594
Y53616-1	1	1" O.D.Tube	.812



TWO-PIECE

ONE-PIECE

SAE - FEMALE SWIVEL - STRAIGHT (45° SEAT) (UNIVERSAL)

BRASS PART NUMBER	SIZE IN.	THREAD	NOMINAL ID IN.
Y54206-93 SAE	3/8	5/8 - 18	.277
Y54006-93 SAE	3/8	5/8 - 18	.277



FEMALE PIPE

STAINLESS STEEL PART NUMBER	BRASS PART NUMBER	SIZE IN.	THREAD	NOMINAL ID IN.
Y53205-95	Y53205-93	5/16	1/4 - 18	.207

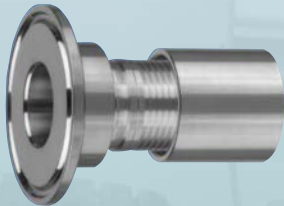

SANITARY TRI CLAMP

STAINLESS STEEL PART NUMBER	HOSE SIZE IN.	FACE DIAMETER	NOMINAL ID IN.
Y51116-4	1	1.984	.812

WARNING: These products can be used to convey hazardous fluids, steam, and other dangerous materials which can cause personal injury or property damage if released through misuse, misapplication, or damaged. The user is responsible to analyze each application prior to specifying any product from this catalog. Due to the wide variety of operating conditions and applications, the user, through personal analysis and testing, is solely responsible for final product selection and meeting all performance, safety, and warning requirements. Careful selection, proper assembly and use of hose fittings and accessories is essential for the safe and warranted operation of the hose assembly.



UNI-BRAID® R165 HOSE

Titeflex R165 series...The original UNI-BRAID® design that outperforms all the others.

APPLICATIONS:

The ultimate transfer hose for a variety of high pressure applications.

- R.I.M. Reaction injection molding machines
- Industrial gasses
- Hydraulic service with phosphate ester fluids
- Compressed natural gas
- Transfer of automotive sealants

TEMPERATURE RANGE:

- -65°F to 400°F (-54°C to 204°C) Consult factory for temperature-adjusted pressure ratings

AVAILABILITY:

- UNI-BRAID® can be fitted and tested to your exact specification by Titeflex or by an authorized Titeflex distributor. Our distributors are selectively certified to assemble high pressure hose assemblies. Insist that your Titeflex product is assembled and supplied by a Titeflex authorized distributor

CRIMP ATTACHMENT:

R165 hose fittings can also be attached using numerous standard hose crimping machines. For information on this alternate method of attachment, please consult us.

UNI-BRAID® high-pressure hose is the most economical high pressure PTFE hose product ever offered to the market. It combines long life expectancy, high durability, and proven performance for superior service and cost effectiveness over the long term.

APPLICATION ADVANTAGES:

- Design optimized for your specific application
- Manufactured in long lengths to reduce hose costs associated with coupling hose sections
- Economical and cost effective
- Greater Flexibility: In industrial hose applications where high performance under harsh conditions is required, Titeflex UNI-BRAID® PTFE hose offers effective solutions and high value. The patented UNI-BRAID® construction features a single outer layer braid that reduces bulk while maximizing pressure capability and provides an exceptionally tight bend radius.
- Hose Construction: R165 hose is made of conductive PTFE using Titeflex "ZS" (Zero Static) construction, to bleed off static build-up in high flow applications and eliminate the risk of "static" burning of the core. NOT for gaseous applications. Please consult factory for gaseous or high effusion media. Reinforcement of combined single plaits of small diameter, tiered, tension controlled type 304 stainless steel wire make up the braid jacket. This specially designed outer layer of braid eliminates conventional spiral wraps, reducing bulk without sacrifice of pressure capability. In larger sizes (-12 thru -24) there is an additional braid layer between the PTFE innercore and the pressure carrying outer braid.

R165 HOSE

HOSE PART NUMBER	NOMINAL SIZE		NOMINAL ID in	NOMINAL OD in	MAX OPERATING PRESSURE† ROOM TEMP psi	ROOM TEMP BURST psi	HIGH TEMP BURST psi	MAXIMUM CONTINUOUS LENGTH ft	MINIMUM BEND RADIUS in	HOSE WEIGHT lb/ft
	in	mm								
R165-4	1/4	6	.222	.390	5,000	15,000	12,000	50	1.50	.100
R165-6	3/8	10	.308	.490	5,000	15,000	12,000	50	2.50	.163
R165-8	1/2	13	.401	.615	5,000	15,000	12,000	50	2.87	.232
R165-10	5/8	16	.495	.730	5,000	15,000	12,000	50	3.25	.325
R165-12	3/4	19	.617	.990	5,000	15,000	12,000	50	3.87	.660
R165-16	1	25	.867	1.270	5,000	15,000	9,000	50	5.00	1.020
R165-20	1-1/4	32	1.118	1.660	5,000	15,000	9,000	33	12.00	1.850
R160-24	1-1/2	38	1.375	1.900	4,000	12,000	9,000	33	14.00	1.910

† Operating pressures shown are for non-impulse service. Consult factory for temperature-adjusted ratings and impulse cycle applications.



These products can be used to convey hazardous fluids, steam, and other dangerous materials which can cause personal injury or property damage if released through misuse, misapplication, or damaged. The user is responsible to analyze each application prior to specifying any product from this catalog. Due to the wide variety of operating conditions and applications, the user, through personal analysis and testing, is solely responsible for final product selection and meeting all performance, safety, and warning requirements.

Careful selection, proper assembly and use of hose fittings and accessories is essential for the safe and warranted operation of the hose assembly.

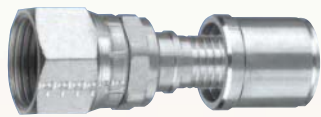

JIC - FEMALE SWIVEL (37° SEAT)

STAINLESS STEEL PART NUMBER	SIZE IN.	THREAD	NOMINAL ID IN.
Y40004-172	1/4	7/16 - 20	.146
Y40006-172	3/8	9/16 - 18	.271
Y40008-172	1/2	3/4 - 16	.365
Y40010-172	5/8	7/8 - 14	.455
Y40012-172	3/4	1 1/16 - 12	.568
Y40016-172	1	1-5/16 - 12	.778
Y40020-172	1-1/4	1-5/8 - 12	.964
Y40024-172	1-1/2	1-7/8 - 12	1.187



ADAPTER - MALE JIC TO MALE PIPE

STAINLESS STEEL PART NUMBER	SIZE IN.	THREAD	NOMINAL ID IN.
94364SS-4	1/8 - 27	7/16 - 20	.172
94364SS-4-4	1/4 - 18	7/16 - 20	.172
94364SS-6	1/4 - 18	9/16 - 18	.297
94364SS-6-6	3/8 - 18	9/16 - 18	.297
94364SS-8	3/8 - 18	3/4 - 16	.390
94364SS-8-8	1/2 - 14	3/4 - 16	.390
94364SS-10	1/2 - 14	7/8 - 14	.484
94364SS-10-6	3/8 - 18	7/8 - 14	.484
94364SS-12	3/4 - 14	1 1/16 - 12	.609
94364SS-16	1 - 11-1/2	1 - 5/16 - 12	.844
94364SS-20	1 1/4 - 11-1/2	1 - 5/8 - 12	1.078
94364SS-24	1-1/2 - 11-1/2	1 - 7/8 - 12	1.313

WARNING: These products can be used to convey hazardous fluids, steam, and other dangerous materials which can cause personal injury or property damage if released through misuse, misapplication, or damaged. The user is responsible to analyze each application prior to specifying any product from this catalog. Due to the wide variety of operating conditions and applications, the user, through personal analysis and testing, is solely responsible for final product selection and meeting all performance, safety, and warning requirements. Careful selection, proper assembly and use of hose fittings and accessories is essential for the safe and warranted operation of the hose assembly.

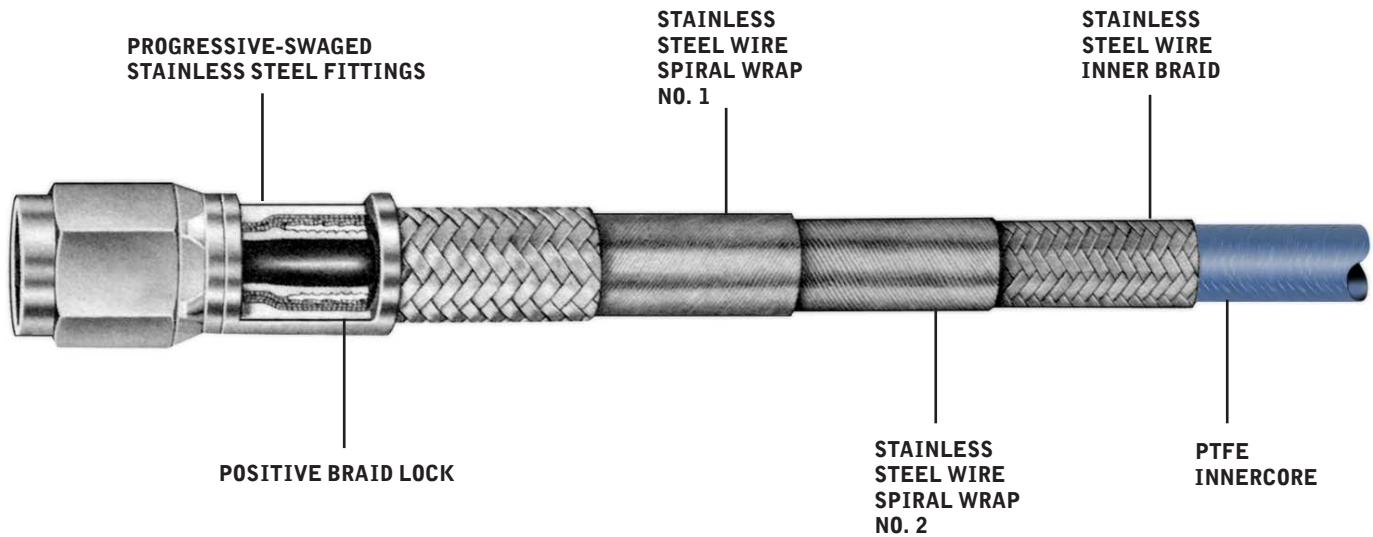
**R154 HOSE**

The ideal choice for high-performance impulse service.

APPLICATIONS:

- The preferred choice for high impulse hydraulic systems
 - Ground support
- Capable of long service life at temperature/pressure extremes
 - Molten plastics
 - Steel mill concast lines

R154 HOSE CONSTRUCTION

R154 offers a smooth innercore of extruded PTFE with a precisely controlled amount of carbon black added to the inner 15% of the core wall. This will allow a continuous conductive path to the metal end fittings. Wire reinforcement is type 304 stainless steel. The ½" size has four layers of spiral wrap between two layers of braid.

TEMPERATURE RANGE:

- -65°F to 400°F (-54°C to 204°C) Consult factory for temperature-adjusted pressure ratings

R154 HIGH PERFORMANCE PTFE HOSE

HOSE PART NUMBER	NOMINAL SIZE		NOMINAL ID in	NOMINAL OD in	MAX OPERATING PRESSURE† ROOM TEMP psi	ROOM TEMP BURST psi	MAXIMUM CONTINUOUS LENGTH ft	MINIMUM BEND RADIUS in	HOSE WEIGHT lb/ft
	in	mm							
R154-4	1/4	6	.229	.495	6,000	24,000	50	3.00	.24
R154-6	3/8	10	.300	.617	6,000	24,000	30	5.00	.40
R154-8	1/2	13	.395	.738	6,000	24,000	30	5.75	.49

† Consult factory for temperature-adjusted ratings.

WARNING

These products can be used to convey hazardous fluids, steam, and other dangerous materials which can cause personal injury or property damage if released through misuse, misapplication, or damaged. The user is responsible to analyze each application prior to specifying any product from this catalog. Due to the wide variety of operating conditions and applications, the user, through personal analysis and testing, is solely responsible for final product selection and meeting all performance, safety, and warning requirements. Careful selection, proper assembly and use of hose fittings and accessories is essential for the safe and warranted operation of the hose assembly.

R154 HOSE FITTINGS

SMOOTHBORE HOSE FITTINGS

HIGH PERFORMANCE

R154 HOSE FITTINGS

R154 hose fittings also utilize the exclusive Titeflex progressive swaging method of attachment, with positive braid lock.

MATERIALS:

All JIC wetted surfaces are type 300 stainless steel.

R154 JIC-FEMALE SWIVEL (37° SEAT)

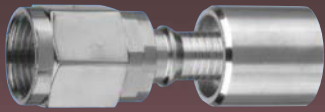

STAINLESS STEEL PART NUMBER	SIZE IN.	THREAD	NOMINAL ID IN.
Y40004-42	1/4	7/16 – 20	.146
Y40006-42	3/8	9/16 – 18	.271
Y40008-42	1/2	3/4 – 16	.365

WARNING: These products can be used to convey hazardous fluids, steam, and other dangerous materials which can cause personal injury or property damage if released through misuse, misapplication, or damaged. The user is responsible to analyze each application prior to specifying any product from this catalog. Due to the wide variety of operating conditions and applications, the user, through personal analysis and testing, is solely responsible for final product selection and meeting all performance, safety, and warning requirements. Careful selection, proper assembly and use of hose fittings and accessories is essential for the safe and warranted operation of the hose assembly.



R272/R276 HOSE

APPLICATIONS:

- Chemical processing
- Pulp and paper
- Foam packaging
- Turbine engine componentry
- Air compressor discharge
- Tire press

TEMPERATURE RANGE:

- -65° F to 400° F (-54° to 204° C)

Consult factory for dynamic flexing applications at temperature limits and temperature adjusted pressure rating

CRIMP ATTACHMENT:

Convoluted fittings can also be attached using numerous standard hose crimping machines. For information on this alternate method of attachment, please consult us.

Unmatched engineering and technical experience in the application of convoluted PTFE hose products has allowed users to consistently rely on Titeflex for dependable performance and value every time.

Titeflex R272/R276 hose is extremely flexible and lightweight offering an improved alternative to maximize operator handling and safety in comparison to other types of industrial hose. Combined with PTFE's unmatched chemical compatibility, corrosion resistance, temperature range and "non-stick" attributes, it offers a superior value.

In addition, R276 offers a black conductive innercore for high flow rate transfer applications where elimination of static charges is required to ensure performance.

R272 HOSE CONSTRUCTION:

A white non-conductive PTFE liner, externally reinforced with PTFE impregnated fiberglass and a single steel wire braid.

R276 HOSE CONSTRUCTION:

The PTFE innercore has a precisely controlled amount of carbon black added to the PTFE innercore. This conductive PTFE core material provides a continuous conductive path to the metal end fittings to bleed off static electricity.

R272/R276 HOSE SPECIFICATIONS

HOSE PART NUMBER	NOMINAL SIZE		NOMINAL ID	NOMINAL OD	OPERATING PRESSURE	BURST PRESSURE ROOM TEMP	MAXIMUM CONTINUOUS LENGTH	MINIMUM BEND RADIUS @ ROOM TEMP	HOSE WEIGHT
	in	mm							
R272/R276-8	1/2	13	.512	.785	1,000	4,000	75	1.00	.22
R272/R276-12	3/4	19	.750	1.060	1,000	4,000	50	2.00	.29
R272/R276-16	1	25	.998	1.280	1,000	4,000	50	3.00	.41
R272/R276-20	1-1/4	32	1.239	1.525	1,000	3,600	50	6.25	.50
R272/R276-24	1-1/2	38	1.500	1.802	750	3,000	50	7.50	.62
R272/R276-32	2	51	1.982	2.305	500	2,000	50	10.00	.97



These products can be used to convey hazardous fluids, steam, and other dangerous materials which can cause personal injury or property damage if released through misuse, misapplication, or damaged. The user is responsible to analyze each application prior to specifying any product from this catalog. Due to the wide variety of operating conditions and applications, the user, through personal analysis and testing, is solely responsible for final product selection and meeting all performance, safety, and warning requirements. Careful selection, proper assembly and use of hose fittings and accessories is essential for the safe and warranted operation of the hose assembly.

R285/R287 FULL VACUUM RATED HOSE

FLEXIBLE PTFE HOSE

CONVOLUTED

TEMPERATURE RANGE:

- -65°F to 400°F (-54°C to 204°C) Consult factory for flexing and vacuum applications at temperature limits

STANDARDS:

- PTFE meets FDA 21 CFR 177.1550

R285 HOSE CONSTRUCTION:

Heavy-wall innercore of convoluted PTFE, externally reinforced with PTFE-impregnated fiberglass, a patented spring wire spiral to prevent collapse, and type 304 stainless steel wire braid.

R287 HOSE CONSTRUCTION:

Conductive hose has a precisely controlled amount of carbon black added to the PTFE innercore. This provides a continuous path to the metal end fittings, to bleed off static electricity, ensuring performance.

Extra heavy duty construction with additional wire support provides the ultimate in flexibility for use in full vacuum conditions.

The R285/287 series hose incorporates a heavy wall PTFE (non-conductive/conductive) innercore reinforced with an external stainless steel wire wrapped in the root of the convolution under the stainless steel braid. This additional wire reinforcement provides unmatched flexibility with the hoop strength necessary for use in full vacuum applications up to 28" Hg.

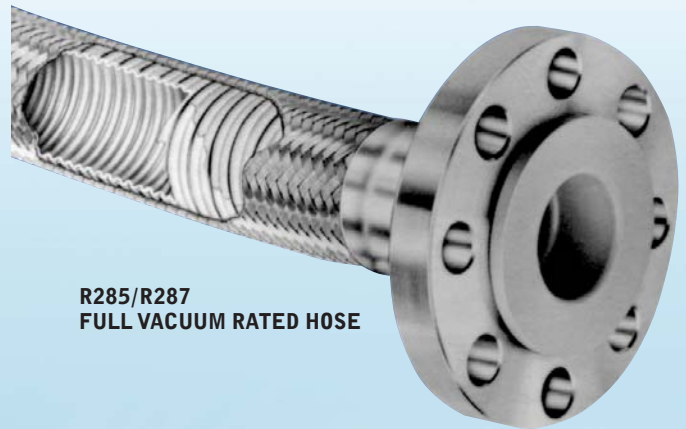

R285/R287
FULL VACUUM RATED HOSE

R285/R287 FULL VACUUM RATED HOSE

HOSE PART NUMBER	NOMINAL SIZE		NOMINAL ID	NOMINAL OD	OPERATING PRESSURE	BURST PRESSURE ROOM TEMP	MAXIMUM CONTINUOUS LENGTH	MINIMUM BEND RADIUS @ ROOM TEMP	HOSE WEIGHT
	in	mm	in	in	psi	psi	ft	in	lb/ft
R285/R287-24	1-1/2	38	1.52	1.900	750	3,000	40	7.50	.882
R285/R287-32	2	51	2.02	2.445	500	1,900	40	10.00	1.194

WARNING: These products can be used to convey hazardous fluids, steam, and other dangerous materials which can cause personal injury or property damage if released through misuse, misapplication, or damaged. The user is responsible to analyze each application prior to specifying any product from this catalog. Due to the wide variety of operating conditions and applications, the user, through personal analysis and testing, is solely responsible for final product selection and meeting all performance, safety, and warning requirements. Careful selection, proper assembly and use of hose fittings and accessories is essential for the safe and warranted operation of the hose assembly.

Our selection of fittings enhances the value, the areas of application and convenience of Titeflex convoluted hose. With these fittings, most installation needs are easily met. Please consult us for any designs or applications not pictured here.

Convoluted hose fittings feature the exclusive Titeflex progressive swaging method of attachment. When attached correctly, the innercore and insert form a permanent assembly. The positive braid lock assures that strain is absorbed by the braid, not the hose innercore, ensuring hose integrity.

CRIMP ATTACHMENT:

Hose may be crimped using numerous standard hose crimping machines. For information on this alternate method of attachment and appropriate applications, please consult us.

MATERIALS:

Male pipe and female inserts are available in carbon steel and type 316 stainless steel. Collars for the preceding fittings are either carbon steel or type 304 stainless steel.

Note: Carbon steel collars may be specified with stainless steel inserts, where only wetted surfaces require corrosion resistance.

AVAILABILITY:

Convoluted hose assemblies can be fabricated by Titeflex or authorized Titeflex distributors. To assure factory-made reliability for distributor assemblies, our distributors are equipped with Titeflex-designed and approved field swaging tools.

MALE PIPE



STAINLESS STEEL PART NUMBER	CARBON STEEL PART NUMBER	SIZE IN.	THREAD	NOMINAL ID IN.
Y53308-100	Y53308-101	1/2	1/2 – 14	.378
Y53312-100	Y53312-101	3/4	3/4 – 14	.630
Y53316-100	Y53316-101	1	1 – 11-1/2	.849
Y53320-100	Y53320-101	1-1/4	1-1/4 – 11-1/2	1.069
Y53324-100	Y53324-101	1-1/2	1-1/2 – 11-1/2	1.306
Y53332-100	Y53332-101	2	2 – 11-1/2	1.756

JIC - FEMALE SWIVEL (37° SEAT)

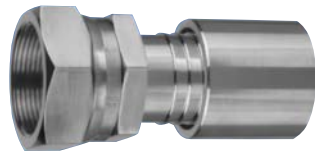

STAINLESS STEEL PART NUMBER	CARBON STEEL PART NUMBER	SIZE IN.	THREAD	NOMINAL ID IN.
Y53508-100	Y53508-101	1/2	3/4 – 16	.378
Y53512-100	Y53512-101	3/4	1-1/16 – 12	.630
Y53516-100	Y53516-101	1	1-5/16 – 12	.849
Y53520-100	Y53520-101	1-1/4	1-5/8 – 12	1.070
Y53524-100	Y53524-101	1-1/2	1-7/8 – 12	1.305
Y53532-100	Y53532-101	2	2-1/2 – 12	1.755

SANITARY FITTING



STAINLESS STEEL PART NUMBER	SIZE IN.	FACE DIAMETER	NOMINAL ID IN.
Y51116-3	1	1.984	.847
Y51124-3	1-1/2	1.984	1.310
Y51132-3	2	2.516	1.756



WARNING

These products can be used to convey hazardous fluids, steam, and other dangerous materials which can cause personal injury or property damage if released through misuse, misapplication, or damaged. The user is responsible to analyze each application prior to specifying any product from this catalog. Due to the wide variety of operating conditions and applications, the user, through personal analysis and testing, is solely responsible for final product selection and meeting all performance, safety, and warning requirements. Careful selection, proper assembly and use of hose fittings and accessories is essential for the safe and warranted operation of the hose assembly.

Titeflex's Tefzel® encapsulated flange retaining inserts are now available in 1", 1-1/2" and 2" sizes. These fittings are manufactured using a base insert of nickel plated carbon steel. The Tefzel® compound is injection molded around this base insert at high pressure. This high pressure injection molding results in a tough zero porosity plastic encapsulation which is highly corrosion resistant. The wall thickness on all wetted surfaces of the flange retaining insert is a minimum of .060".

Dependent on media, temperature capability of the encapsulated stub end is 250°F. Consult factory for detailed information on fluid capability and temperature rating.

MATERIALS:

Flange retaining inserts are available in type 316 stainless steel, or with Halar® coating.

Tefzel® encapsulated flange retaining inserts are available with a base material of nickel plated carbon steel.

Collars for all styles are available in either type 304 stainless steel or plated carbon steel.



FLANGE RETAINING INSERT TEFZEL® ENCAPSULATED

TEFZEL® ENCAPSULATED STAINLESS STEEL COLLAR	TEFZEL® ENCAPSULATED CARBON STEEL COLLAR	SIZE IN.	NOMINAL ID IN.
Y53416-97H	Y53416-91H	1	.740
Y53424-97H	Y53424-91H	1-1/2	1.220
Y53432-97H	Y53432-91H	2	1.706

FLANGE RETAINING INSERTS: STAINLESS STEEL

STAINLESS STEEL PART NUMBER	SIZE IN.	NOMINAL ID IN.
Y53412-100	3/4	.630
Y53416-100	1	.850
Y53424-100	1-1/2	1.305
Y53432-100	2	1.756

WARNING: These products can be used to convey hazardous fluids, steam, and other dangerous materials which can cause personal injury or property damage if released through misuse, misapplication, or damaged. The user is responsible to analyze each application prior to specifying any product from this catalog. Due to the wide variety of operating conditions and applications, the user, through personal analysis and testing, is solely responsible for final product selection and meeting all performance, safety, and warning requirements. Careful selection, proper assembly and use of hose fittings and accessories is essential for the safe and warranted operation of the hose assembly.



APPLICATIONS:

- Size 1" chlorine hose for rail car loading and unloading
- Titeflex 1/2" chlorine hose for replacing copper whips at chlorine repackaging plants filling 1 ton containers and 100/150 lb. cylinders

TEMPERATURE RANGE:

- -40°F to 120°F (-40°C to 49°C)

WARRANTY INFORMATION:

- Please refer to page 26 of this catalog or Titeflex.com

PROVEN PERFORMANCE:

- Engineered specifically to meet the critical application conditions of chlorine transfer
- Used worldwide by major chemical producers
- Meets or exceeds the Chlorine Institute guidelines, Pamphlet 6 Appendix A

Chlorine transfer is recognized as one of the most challenging and potentially hazardous hose applications. Aware of the clear need for safety, reliability and performance, Titeflex has engineered a unique product to meet the demands of this critical application. Titeflex S818XX chlorine hoses are internationally accepted and recognized for providing many years of unparalleled safety and performance.

S818XX assemblies are more flexible and resilient than metal hose. The PTFE innercore is virtually stress-free in continuous flexing installations. The convolutions of Titeflex chlorine hose are shallow and helical, rather than annular as in metal hose, to facilitate draining and cleaning and reduce transfer time cycles.

Titeflex chlorine transfer hose is currently available in 1/2" and 1" ID's. It offers full flow characteristics for faster loading and unloading and are supplied directly from the Titeflex plant in lengths from one to 50 feet.

For quality assurance and traceability, each factory-made and tested assembly is serialized and recorded at Titeflex, along with the installation location and date. The assembly is also clearly tagged with its pressure and temperature ratings.

CONSTRUCTION:

- Convoluted PTFE core with a double layer of braid
- 1" hoses are covered with a CPE jacket for abrasion protection
- New optional heavy duty high density polyethylene spiral wrap available
- Schedule 80 monel male pipe fittings
- Monel schedule MSS type A stub ends available for 1" size
- 1/2" size males have a press-fit liner/insert to prevent erosion



These products can be used to convey hazardous fluids, steam, and other dangerous materials which can cause personal injury or property damage if released through misuse, misapplication, or damaged. The user is responsible to analyze each application prior to specifying any product from this catalog. Due to the wide variety of operating conditions and applications, the user, through personal analysis and testing, is solely responsible for final product selection and meeting all performance, safety, and warning requirements. Careful selection, proper assembly and use of hose fittings and accessories is essential for the safe and warranted operation of the hose assembly.

MONEL MALE NPT EACH END SPECIFICATIONS

ASSEMBLY PART NUMBER	NOMINAL SIZE		NOMINAL ID	NOMINAL OD	MAXIMUM OPERATING PRESSURE	BURST PRESSURE ROOM TEMP	MAXIMUM CONTINUOUS LENGTH	MINIMUM BEND RADIUS @ ROOM TEMP	HOSE WEIGHT	FITTING THREAD NPT
	in	mm	in	in	psi	psi	ft	in	lb/ft	
S81808-L	1/2	13	.500	.900	500	2,000	50	2.00	.22	1/2 – 14
S81816-L	1	25	1.000	1.875	375	1,875	50	6.00	1.00	1 – 11-1/2

ALTERNATE END FITTING STYLE

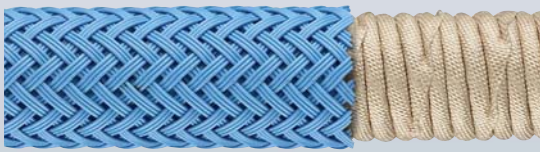

ASSEMBLY PART NUMBER	HOSE SIZE, IN.	END FITTING
111451-L	1	MALE NPT & FLANGE*
111437-L	1	FLANGE X FLANGE

S818XX PTFE CHLORINE/BROMINE HOSE

* Flange retainer is Monel Schedule 80, MSS type A above piece construction with no welds.
Flange is 300 lb. ASME forged steel.

WARNING: These products can be used to convey hazardous fluids, steam, and other dangerous materials which can cause personal injury or property damage if released through misuse, misapplication, or damaged. The user is responsible to analyze each application prior to specifying any product from this catalog. Due to the wide variety of operating conditions and applications, the user, through personal analysis and testing, is solely responsible for final product selection and meeting all performance, safety, and warning requirements. Careful selection, proper assembly and use of hose fittings and accessories is essential for the safe and warranted operation of the hose assembly.

MATERIAL COMPATIBILITY KEY:

1. Excellent **2.** Acceptable with Limited Service Life **3.** Not Recommended **0.** No Information, Test Before Using. Consult factory for other than room temperature applications.

EFFUSION COMPATIBILITY KEY:

A. Will effuse and can displace breathable air in a confined space. **B.** Potential to effuse and, with atmosphere, form chemicals that can corrode braid and fitting material. Especially significant when “vapor phase” exists, I.E., when they reach their boiling point of approximately 125° F at atmospheric pressure. Hose assemblies should be used in well-vented areas only. **C.** Potential for effusion and can cause corrosion of the hose braid reinforcement and fitting material. These chemicals are all gases at atmospheric pressure and at temperatures of 56° F or lower. N/C. No change.

ELECTROSTATIC DISCHARGE:

In many industrial plants, there is an awareness that electrostatic discharge can be a hazard. This discharge is the result of two unlike materials coming into contact. This contact allows electrons from one material to move across its boundary and associate with the other. For example, electrons from steam can align with the wall of a PTFE hose. If both materials are good conductors of electricity, the positive and negative electrons flow back and forth between the chemical and hose wall, keeping them in balance. However, if one or both of them are insulators, the balance will be disrupted. As a result, chemicals such as gasoline or steam flowing through a white PTFE hose will deposit electrons on the wall of the innercore, building up static charge. When the charge exceeds the dielectric strength of the hose wall, dielectric breakdown occurs.

CHEMICAL	PTFE	FITTING MATERIAL				EFFUSION
		CS	304SS	316SS	BRASS	
Acetaldehyde	1	1	1	1	1	B
Acetic Acid Glacial	1	0	2	1	3	
Acetic Acid 30%	1	0	2	1	3	
Acetic Anhydride	1	3	2	2	3	
Acetone	1	1	1	1	1	
Acetylene	1	0	2	2	2	C
Acrylonitrile	1	0	2	2	2	
Alum Ammonium or Potassium	1	3	3	2	2	
Aluminum Acetate	1	0	1	1	3	
Aluminum Bromide	1	3	2	2	3	
Aluminum Chloride	1	3	2	2	3	
Aluminum Flouride	1	3	2	2	3	
Aluminum Hydroxide	1	0	1	1	1	
Aluminum Nitrate	1	3	1	1	0	
Aluminum Salts	1	0	2	2	0	
Aluminum Sulfate	1	3	3	2	3	
Ammonia, Anhydrous	1	1	1	1	0	
Ammonia, Aqueous	1	0	1	1	3	
Ammonium Carbonate	0	1	1	1	0	
Ammonium Chloride	1	0	2	2	3	
Ammonium Hydroxide	1	2	1	1	3	
Ammonium Metaphosphate	1	1	1	1	0	
Ammonium Nitrate	1	1	1	1	3	
Ammonium Nitrite	0	0	1	1	3	
Ammonium Persulfate	3	0	1	1	0	

CHEMICAL	PTFE	FITTING MATERIAL				EFFUSION
		CS	304SS	316SS	BRASS	
Ammonium Phosphate	1	3	2	1	0	
Ammonium Sulphate	1	3	1	1	3	
Ammonium Thiocyanate	1	3	3	1	0	
Amyl Acetate	1	3	1	1	2	
Amyl Alcohol	1	2	1	1	1	
Amyl Chloride	1	1	1	1	1	
Amyl Chloronaphthalene	1	0	1	1	0	
Amyl Naphthalene	1	0	1	1	0	
Aniline	1	2	1	1	3	
Aniline Dyes	1	3	1	1	3	
Aniline Hydrachloride	1	3	3	3	3	
Animal Fats	1	1	1	1	0	
Aqua Regia	1	3	2	2	3	
Arsenic Acid	1	3	3	1	2	
Askarel	0	1	1	1	1	
Asphalt	1	1	1	1	1	
Barium Carbonate	1	2	1	1	1	
Barium Chloride	1	2	1	1	2	
Barium Hydroxide	1	3	1	1	3	
Barium Sulfate	1	1	1	1	2	
Barium Sulfide	1	3	1	1	3	
Beer	1	2	1	1	1	
Beet Sugar Liquors	1	1	1	1	0	
Benzene	1	1	1	1	1	
Benzenesulfonic Acid	0	3	2	2	2	

Fitting material ratings are based on a fluid temperature of 70° F. Higher temperatures may accelerate adverse effects. Consult Titeflex engineering.



WARNING

These products can be used to convey hazardous fluids, steam, and other dangerous materials which can cause personal injury or property damage if released through misuse, misapplication, or damaged. The user is responsible to analyze each application prior to specifying any product from this catalog. Due to the wide variety of operating conditions and applications, the user, through personal analysis and testing, is solely responsible for final product selection and meeting all performance, safety, and warning requirements. Careful selection, proper assembly and use of hose fittings and accessories is essential for the safe and warranted operation of the hose assembly.

CHEMICAL RESISTANCE DATA

FLEXIBLE PTFE HOSE

TITFLEX®

CHEMICAL	PTFE	FITTING MATERIAL				EFFUSION
		CS	304SS	316SS	BRASS	
Benzaldehyde	1	2	1	1	1	
Benzene	1	1	1	1	1	B
Benzyl Alcohol	1	2	1	1	1	
Benzyl Benzoate	1	1	1	1	0	
Benzyl Chloride	1	1	0	0	0	
Bismuth Carbonate	1	1	1	1	0	
Black Sulphate Liquor	1	2	2	1	3	
Blast Furnace Gas	1	1	1	1	1	C
Borax	1	2	1	1	1	
Bordeaux Mixture	1	0	1	1	0	
Baric Acid	1	3	1	1	2	
Bunker Oil	1	1	1	1	1	
Butadine	1	1	1	1	1	
Butane	1	1	1	1	1	C
Butter Oil	1	1	1	1	1	
Butyric Acid	1	3	1	1	2	
Butyl Acetate	1	2	1	1	2	
Butyl Alcohol	1	1	1	1	1	
Butyl Amine	0	1	1	1	1	
Butyl Carbitol	1	1	1	1	1	
Butyl Stearate	1	1	1	1	1	
Butyl Mercaptan	1	0	1	1	0	
Butraldehyde	1	0	0	0	1	
Calcium Acetate	1	1	1	1	1	
Calcium Bisulfate	1	0	2	1	3	
Calcium Bisulfite	1	3	1	1	3	
Calcium Carbonate	1	2	1	1	3	
Calcium Chlorate	1	2	2	1	2	
Calcium Chloride	1	3	2	1	2	
Calcium Hydroxide	1	3	1	1	3	
Calcium Hypochlorite	1	3	2	2	3	
Calcium Nitrate	1	2	1	1	1	
Calcium Silicate	1	1	1	1	1	B
Calcium Sulfate	1	1	1	1	1	
Calcium Sulfide	1	1	1	1	0	
Cane Sugar Liquors	1	1	1	1	2	
Carbolic Acid	1	3	1	1	3	
Carbon Dioxide	1	1	1	1	1	A
Carbon Disulfide	0	2	1	1	2	
Carbonic Acid	1	3	1	1	3	
Carbon Monoxide	1	1	1	1	1	C
Carbon Tetrachloride	1	2	1	1	2	
Castor Oil	1	1	1	1	1	
Caustic Soda	1	2	1	1	3	
Cellosolve, Acetate	1	0	2	2	1	

CHEMICAL	PTFE	FITTING MATERIAL				EFFUSION
		CS	304SS	316SS	BRASS	
Cellosolve, Butyl	1	1	1	1	1	
Cellulube	1	1	1	1	1	
Chlorine, Gaseous, Dry*	*	2	3	3	2	C
Chlorine, Gaseous, Wet*	*	3	3	3	3	B
Chlorine Trifluoride	0	3	0	0	0	C
Chloroacetic Acid	1	3	3	3	3	
Chlorobenzene	1	1	1	1	1	
Chlorobromomethane	1	1	1	1	1	
Chloroform	1	1	1	1	1	
O-Chloronaphthalene	1	1	1	1	1	
Chlorotoluene	1	1	1	1	1	
Chromic Acid	1	3	3	2	3	
Citric Acid	1	3	3	1	3	
Cod Liver Oil	1	1	1	1	1	
Coke Oven Gas	1	1	1	1	0	
Compressed Natural Gas (CNG) ¹	0	1	1	1	2	A ¹
Copper Chloride	1	3	3	1	3	
Copper Cyanide	1	0	1	1	3	
Copper Sulfate	1	3	1	1	3	
Corn Oil	1	1	1	1	1	
Corn Syrup	1	1	1	1	0	
Cottonseed Oil	1	1	1	1	1	
Creosote	1	2	1	1	3	
Cresol	1	2	1	1	0	
Crude Wax	1	1	1	1	1	
Cutting Oil	1	1	1	1	1	
Cyclohexane	1	1	1	1	1	
Cyclohexanome	1	0	1	1	0	
Cymene	1	0	0	0	1	
Decaline	1	0	0	0	1	
Denatured Alcohol	1	1	1	1	1	
Diacetone	1	1	1	1	1	
Diacetone Alcohol	1	1	1	1	1	
Dibenzyl Ether	1	1	1	1	1	
Dibutyl Ether	1	1	1	1	1	
Dibutyl Phthalate	1	1	1	1	1	
Dibutyl Sebacate	1	1	1	1	1	
Dichlorobenzene	1	0	1	1	1	
Diesel Oil	1	1	1	1	1	
Diethylamine	1	3	0	2	3	
Diethyl Ether	1	1	1	1	1	B
Diethylene Glycol	1	1	1	1	1	
Diethyl Phthalate	1	0	1	1	1	
Diethyl Sebacate	1	0	1	1	1	
Di-Isobutylene	0	0	1	1	1	

Fitting material ratings are based on a fluid temperature of 70° F. Higher temperatures may accelerate adverse effects. Consult Titeflex engineering.

¹ Consult Titeflex engineering

* Refer to page 17 for chlorine/bromine hose. Do not use stainless steel braided PTFE hose.

WARNING: These products can be used to convey hazardous fluids, steam, and other dangerous materials which can cause personal injury or property damage if released through misuse, misapplication, or damaged. The user is responsible to analyze each application prior to specifying any product from this catalog. Due to the wide variety of operating conditions and applications, the user, through personal analysis and testing, is solely responsible for final product selection and meeting all performance, safety, and warning requirements. Careful selection, proper assembly and use of hose fittings and accessories is essential for the safe and warranted operation of the hose assembly.

CHEMICAL	PTFE	FITTING MATERIAL				EFFUSION
		CS	304SS	316SS	BRASS	
Di-Isopropyl Keytone	1	0	1	1	1	
Dimethyl Aniline	1	0	0	0	1	
Dimethyl Formamide	0	1	1	1	0	
Dimethyl Phthalate	1	0	0	0	1	
Diocetyl Phthlate	1	1	1	1	1	
Dioxane	1	1	1	1	1	
Dipentene	1	1	1	1	1	
Ethanolamine	1	1	1	1	1	
Ethyl Acetate	1	1	1	1	1	
Ethyl Acetoacetate	1	1	1	1	1	
Ethyl Atrylate	0	1	1	1	0	
Ethyl Alcohol	1	1	1	1	1	
Ethyl Benzene	1	1	1	1	1	
Ethyl Cellulose	1	1	1	1	1	
Ethyl Chloride	1	2	1	1	2	
Ethyl Ether	1	2	1	1	2	
Ethyl Mertaptan	1	2	0	0	2	B
Ethyl Pentochlorobenzene	1	2	1	1	1	
Ethyl Silicate	1	1	1	1	1	
Ethylene Chloride	1	2	1	1	2	
Ethylene Chlorohydrin	1	0	0	0	0	
Ethylene Diamine	1	0	1	0	1	
Ethylene Glycol	1	2	1	1	1	
Fatty Acids	1	0	1	1	0	
Ferric Chloride	1	3	3	3	3	
Ferric Nitrate	1	3	1	1	0	
Ferric Sulfate	1	3	1	1	3	
Ferrous Chloride	1	3	1	2	2	
Ferrous Nitrate	1	3	1	1	3	
Ferrous Sulfate	1	3	1	1	2	
Fluoroboric Acid	1	0	1	1	0	
Formaldehyde	1	2	1	1	2	
Formic Acid	1	3	2	1	2	
Freon 12	2	3	1	1	0	A
Freon 21	2	3	1	1	0	A
Freon 22	2	3	1	1	0	A
Freon 113	2	3	1	1	0	A
Freon 114	2	3	1	1	0	A
Fuel Oil	1	1	1	1	1	
Fumaric Acid	0	0	1	1	0	
Furon Furfuran	1	1	1	1	1	
Furfural	1	2	1	1	1	
Gallic Acid	1	3	1	1	0	

CHEMICAL	PTFE	FITTING MATERIAL				EFFUSION
		CS	304SS	316SS	BRASS	
Gasoline	1	1	1	1	1	
Glauber's Salt	0	1	1	1	0	
Glucose	1	1	1	1	1	
Glue	1	2	1	1	1	
Glycerin	1	2	1	1	1	
Glycols	1	1	1	1	1	
Green Sulfate Liquor	1	1	1	1	0	
n-Hexaldehyde	1	1	1	1	1	
Hexane	1	1	1	1	1	
Hexene	1	1	1	1	1	
Hexyl Alcohol	1	1	1	1	2	
Hydraulic Oil, Petroleum	1	1	1	1	1	
Hydrochloric Acid, 15%	1	3	3	3	3	B
Hydrochloric Acid, 37%	1	3	3	3	3	B
Hydrochromic Acid	1	3	3	3	3	
Hydrofluoric Acid, Concentrated	1	3	3	3	3	
Hydrofluosilicic Acid	1	0	2	2	3	
Hydrogen, Gaseous	**	1	1	1	1	C
Hydrogen Peroxide, 70%	1	2	3	1	3	
Hydrogen Sulfide, Gaseous	1	3	2	1	3	C
Hydroquinone	0	1	1	1	0	
Isobutyl Alcohol	1	1	1	1	1	
Iso Octane	1	1	1	1	1	
Isopropyl Acetate	1	1	1	1	1	
Isopropyl Alcohol	1	1	1	1	1	
Isopropyl Ether	1	1	1	1	1	
JP3 Fuel	1	1	1	1	1	
JP4 Fuel	1	1	1	1	1	
JP5 Fuel	1	1	1	1	1	
JP6 Fuel	1	1	1	1	1	
JP8 Fuel	1	1	1	1	1	
Kerosene	1	1	1	1	1	
Ketones	1	1	1	1	1	
Lacquers	1	3	3	1	1	
Lacquer Solvents	1	3	3	1	1	B
Lactic Acid	1	3	2	1	2	
Lard	1	1	1	1	3	
Lead Acetate	1	3	0	1	1	
Lead Nitrate	0	1	1	1	0	
Lime Bleath	0	3	2	1	0	
Linoleic Acid	1	3	2	2	3	
Linseed Oil	1	1	1	1	1	
Lubricating Oils, Petroleum	1	1	1	1	1	
Magnesium Chloride	1	3	3	3	2	
Magnesium Hydroxide	1	1	1	1	0	
Magnesium Sulfate	1	1	1	1	1	

Fitting material ratings are based on a fluid temperature of 70° F. Higher temperatures may accelerate adverse effects. Consult Titeflex engineering.

** Caution: explosive, consult Titeflex engineering.



These products can be used to convey hazardous fluids, steam, and other dangerous materials which can cause personal injury or property damage if released through misuse, misapplication, or damaged. The user is responsible to analyze each application prior to specifying any product from this catalog. Due to the wide variety of operating conditions and applications, the user, through personal analysis and testing, is solely responsible for final product selection and meeting all performance, safety, and warning requirements. Careful selection, proper assembly and use of hose fittings and accessories is essential for the safe and warranted operation of the hose assembly.

CHEMICAL RESISTANCE DATA

FLEXIBLE PTFE HOSE

TITFLEX®

CHEMICAL	PTFE	FITTING MATERIAL				EFFUSION
		CS	304SS	316SS	BRASS	
Molic Acid	1	2	2	1	0	
Mercuric Chloride	1	3	1	1	3	
Mercury	1	1	1	1	3	
Mesityl Oxide	1	1	1	1	1	
Methyl Acetate	1	2	1	1	1	
Methyl Atrylote	0	1	1	1	1	
Methyl Alcohol	1	1	1	1	2	
Methyl Bromide	1	0	2	2	0	B
Methyl Butyl Ketone	0	1	1	1	1	
Methyl Chloride	1	1	1	1	1	B
Methylene Chloride	1	1	1	1	3	
Methyl Ethyl Ketone (MEK)	1	1	1	1	1	
Methyl Formate	1	0	1	1	3	B
Methyl Isobutyl Ketone	1	1	1	1	1	
Methyl Methacrylate	1	1	1	1	0	
Methyl Salicylate	1	1	1	1	1	
Milk	1	3	1	1	3	
Mineral Oil	1	1	1	1	1	
Monochlorobenzene	1	1	1	1	1	
Monoethanolamine	0	1	1	1	1	
Naphtha	1	2	1	1	1	
Naphthalene	1	2	2	2	0	
Naphthenic Acid	1	0	2	1	0	
Natural Gas†	0	1	1	1	2	A†
Nickel Acetate	1	1	1	1	1	
Nickel Chloride	1	3	2	2	3	
Nickel Sulfate	1	0	2	1	3	
Niter Coke	0	3	2	1	0	
Nitric Acid, All Concentrations	1	3	2	2	3	
Nitric Acid, Red Fuming	1	3	3	2	3	
Nitrobenzene	1	1	1	1	1	
Nitroethane	1	0	1	1	1	
Nitrogen, Gaseous	1	1	1	1	1	A
Nitrogen Telroxide	0	0	0	2	0	
n-Octane	0	1	1	1	1	
Octyl Alcohol	1	3	1	1	2	
Oil, SAE	1	1	1	1	1	
Oleic Acid	1	3	3	1	2	
Olive Oil	1	1	1	1	1	
Oxalic Acid	1	3	1	1	3	
Oxygen, Gaseous****	1	1	1	1	1	A
Ozone	1	1	1	1	1	
Paint	1	1	1	1	1	
Palmitic Acid	1	2	1	1	1	
Peanut Oil	1	1	1	1	1	

CHEMICAL	PTFE	FITTING MATERIAL				EFFUSION
		CS	304SS	316SS	BRASS	
Perchloric Acid	1	0	2	2	0	
Perchloroethylene	1	2	1	1	1	
Petroleum	1	1	1	1	1	
Phenol	1	3	1	1	3	
Phorone	1	1	1	1	1	
Piric Acid	1	3	1	1	3	
Pinene	1	1	1	1	1	
Pine Oil	1	2	1	1	0	
Plating Solution, Chrome	1	0	3	3	0	
Potassium Acetate	1	3	2	2	0	
Potassium Chloride	1	1	2	2	2	
Potassium Cyanide	1	2	1	1	3	
Potassium Dichromate	1	3	1	1	0	
Potassium Hydroxide, 30%	1	3	1	1	3	
Potassium Nitrate	1	3	1	1	2	
Potassium Sulfate	1	1	1	1	2	
Propane	1	1	1	1	1	A
Propyl Acetate	0	1	1	1	1	
Propyl Alcohol	1	1	1	1	1	
Pyridine, 50%	1	1	1	1	1	
Red Oil	1	2	2	1	2	
Salicylic Acid	0	3	1	1	0	
Salt Water	1	3	3	2	3	
Sewage	1	3	1	1	1	
Silicon Tetrafluoride (STF)	0	3	2***	2***	3	C
Silicone Greases	0	1	1	1	1	
Silicone Oils	0	1	1	1	1	
Silver Nitrate	1	3	1	1	3	
Skydrol 500 & 7000	1	1	1	1	0	
Soap Solutions	1	1	1	1	1	
Soda Ash	1	1	1	1	2	
Sodium Acetate	1	3	1	1	0	
Sodium Bicarbonate	1	3	1	1	2	
Sodium Bisulfite	1	3	1	1	3	
Sodium Borate	1	1	1	1	0	
Sodium Chloride	1	2	2	2	1	
Sodium Cyanide	1	2	1	1	3	
Sodium Hydroxide, 40%	1	2	1	1	3	
Sodium Hypochlorite	1	3	3	2	3	
Sodium Metaphosphate	1	3	1	1	3	
Sodium Nitrate	1	1	1	1	2	
Sodium Perborate	1	3	1	1	3	
Sodium Peroxide	1	3	1	1	3	
Sodium Phosphate	1	2	1	1	3	
Sodium Thiosulfate	1	3	1	1	3	

Fitting material ratings are based on a fluid temperature of 70° F. Higher temperatures may accelerate adverse effects. Consult Titeflex engineering.

† Consult Titeflex engineering

*** Highly corrosive, consult Titeflex engineering

**** Special cleaning required. Consult Titeflex engineering

WARNING: These products can be used to convey hazardous fluids, steam, and other dangerous materials which can cause personal injury or property damage if released through misuse, misapplication, or damaged. The user is responsible to analyze each application prior to specifying any product from this catalog. Due to the wide variety of operating conditions and applications, the user, through personal analysis and testing, is solely responsible for final product selection and meeting all performance, safety, and warning requirements. Careful selection, proper assembly and use of hose fittings and accessories is essential for the safe and warranted operation of the hose assembly.

CHEMICAL	PTFE	FITTING MATERIAL				EFFUSION
		CS	304SS	316SS	BRASS	
Soybean Oil	1	1	1	1	0	
Stannic Chloride	1	3	3	3	3	
Steam	1	3	1	1	1	A
Stearic Acid	1	3	2	1	3	
Stoddard Solvent	1	1	1	1	1	
Styrene	1	2	0	2	2	
Sucrose Solution	1	1	1	1	1	
Sulfur, 200° F	1	3	1	1	3	
Sulfur Chloride	1	3	3	2	3	
Sulfur Dioxide	1	2	1	1	1	C
Sulfur Trioxide	1	3	2	2	3	B
Sulfuric Acid, 10%	1	3	2	3	3	
Sulfuric Acid, 98%	1	2	3	2	3	
Sulfuric Acid, Fuming	1	3	3	2	3	
Sulfurous Acid, 10%	1	3	2	1	3	
Sulfurous Acid, 75%	1	3	3	2	3	
Tanic Acid, 10%	1	2	1	1	3	
Tar, Bituminous	1	1	1	1	2	
Tartaric Acid	1	3	1	1	3	
Terpineol	1	0	0	0	0	
Titanium Tetrachloride	0	3	2	2	3	
Toluene	1	1	1	1	1	
Toluene Diisocyanate	0	0	0	0	0	
Transformer Oil	1	1	1	1	1	

CHEMICAL	PTFE	FITTING MATERIAL				EFFUSION
		CS	304SS	316SS	BRASS	
Transmission Fluid, Type A	1	1	1	1	1	
Tributoxyethyl Phosphate	1	0	1	1	0	
Tributyl Phosphate	1	1	0	0	0	
Trichloroethylene	1	2	1	1	1	
Tricresyl Phosphate	1	1	0	2	0	
Tung Oil	1	1	1	1	1	
Turpentine	1	1	1	1	2	
Urea Solution, 50%	1	1	1	1	0	
Varnish	0	3	1	1	2	
Vegetable Oils	1	1	1	1	1	
Versilube	1	1	1	1	1	
Vinegar	1	3	1	1	3	
Vinyl Chloride	1	2	1	1	3	C
Water	1	2	1	1	1	
Whiskey, Wines	1	3	2	1	3	
Xylene	1	2	2	2	3	
Zinc Acetate	1	1	1	1	1	
Zinc Chloride	1	3	2	1	3	
Zinc Sulfate	1	3	2	1	3	

Fitting material ratings are based on a fluid temperature of 70° F. Higher temperatures may accelerate adverse effects. Consult Titeflex engineering.

SIZE	TEMPERATURE/OPERATING PRESSURE: R115, R122, R105, R144								
	65 F° 18 C°	100 F° 38 C°	150 F° 66 C°	200 F° 93 C°	250 F° 121 C°	300 F° 149 C°	350 F° 177 C°	400 F° 204 C°	450 F° 232 C°
-3, -4, -5	3000	2922	2810	2698	2586	2474	2362	2250	2138
-6	2500	2435	2341	2248	2155	2062	1968	1875	1782
-8	2000	1948	1873	1799	1724	1649	1575	1500	1425
-10	1500	1461	1405	1349	1293	1237	1181	1125	1069
-12	1200	1169	1124	1079	1034	990	945	900	855
-16, -20Z	1000	974	937	899	862	825	787	750	713

SIZE	TEMPERATURE/OPERATING PRESSURE: R160, R165								
	65 F° 18 C°	100 F° 38 C°	150 F° 66 C°	200 F° 93 C°	250 F° 121 C°	300 F° 149 C°	350 F° 177 C°	400 F° 204 C°	450 F° 232 C°
-4, -6, -8, -10, -12, -16	5000	4869	4683	4496	4310	4123	3937	3750	3563

SIZE	TEMPERATURE/OPERATING PRESSURE: R272, R276								
	65 F° 18 C°	100 F° 38 C°	150 F° 66 C°	200 F° 93 C°	250 F° 121 C°	300 F° 149 C°	350 F° 177 C°	400 F° 204 C°	450 F° 232 C°
-8, -10, -12, -16, -20	1000	974	937	899	862	825	787	750	713
-24	750	730	702	674	646	618	590	563	535
-32	500	487	468	450	431	412	394	375	356



WARNING

These products can be used to convey hazardous fluids, steam, and other dangerous materials which can cause personal injury or property damage if released through misuse, misapplication, or damaged. The user is responsible to analyze each application prior to specifying any product from this catalog. Due to the wide variety of operating conditions and applications, the user, through personal analysis and testing, is solely responsible for final product selection and meeting all performance, safety, and warning requirements. Careful selection, proper assembly and use of hose fittings and accessories is essential for the safe and warranted operation of the hose assembly.

CRIMP AND SWAGE DIMENSIONS

FLEXIBLE PTFE HOSE

TITFLEX®

HOSE	SIZE	QS SWAGE/CRIMP	PROOF TEST
R115/R122	-4	.350 +/- .003	4,500 PSI
R115/R122	-5	.404 +/- .003	4,500 PSI
R115/R122	-6	.478 +/- .003	3,750 PSI
R115/R122	-8	.568 +/- .003	3,000 PSI
R115/R122	-10	.673 +/- .003	2,250 PSI
R115/R122	-12	.800 +/- .003	1,800 PSI
R115/R122	-16	1.046 +/- .003	1,500 PSI

HOSE	SIZE	TK2 SWAGE/CRIMP	PROOF TEST
R115/R122	-4	.350 +/- .005	4,500 PSI
R115/R122	-5	.404 +/- .005	4,500 PSI
R115/R122	-6	.478 +/- .005	3,750 PSI
R115/R122	-8	.568 +/- .005	3,000 PSI
R115/R122	-10	.673 +/- .005	2,250 PSI
R115/R122	-12	.800 +/- .005	1,800 PSI
R115/R122	-16	1.057 +/- .005	1,500 PSI

HOSE	SIZE	CRIMP/SWAGE	PROOF TEST
R105/R144	-4	.375 +/- .005	4,500 PSI
R105/R144	-5	.432 +/- .005	4,500 PSI
R105/R144	-6	.498 +/- .005	3,750 PSI
R105/R144	-8	.585 +/- .005	3,000 PSI
R105/R144	-10	.724 +/- .005	2,250 PSI
R105/R144	-12	.818 +/- .005	1,800 PSI
R105/R144	-16	1.066 +/- .005	1,500 PSI
R105/R144	-20Z	1.452 +/- .005	1,500 PSI

HOSE	SIZE	SWAGE/CRIMP	PROOF TEST
R272/R276	-8	.781 +/- .010	1,500 PSI
R272/R276	-10	.884 +/- .005	1,500 PSI
R272/R276	-12	1.063 +/- .005	1,500 PSI
R272/R276	-16	1.295 +/- .005	1,500 PSI
R272/R276	-20	1.547 +/- .005	1,500 PSI
R272/R276	-24	1.810 +/- .005	1,125 PSI
R272/R276	-32	2.375 +/- .010	750 PSI

	SIZE	SWAGE	PROOF TEST
R160/R165	-4	.465 +/- .005	10,000 PSI
R160/R165	-6	.560 +/- .005	10,000 PSI
R160/R165	-8	.698 +/- .005	10,000 PSI
R160/R165	-10	.802 +/- .005	10,000 PSI
R160/R165	-12	1.056 +/- .005	10,000 PSI
R160/R165	-16	1.340 +/- .005	10,000 PSI

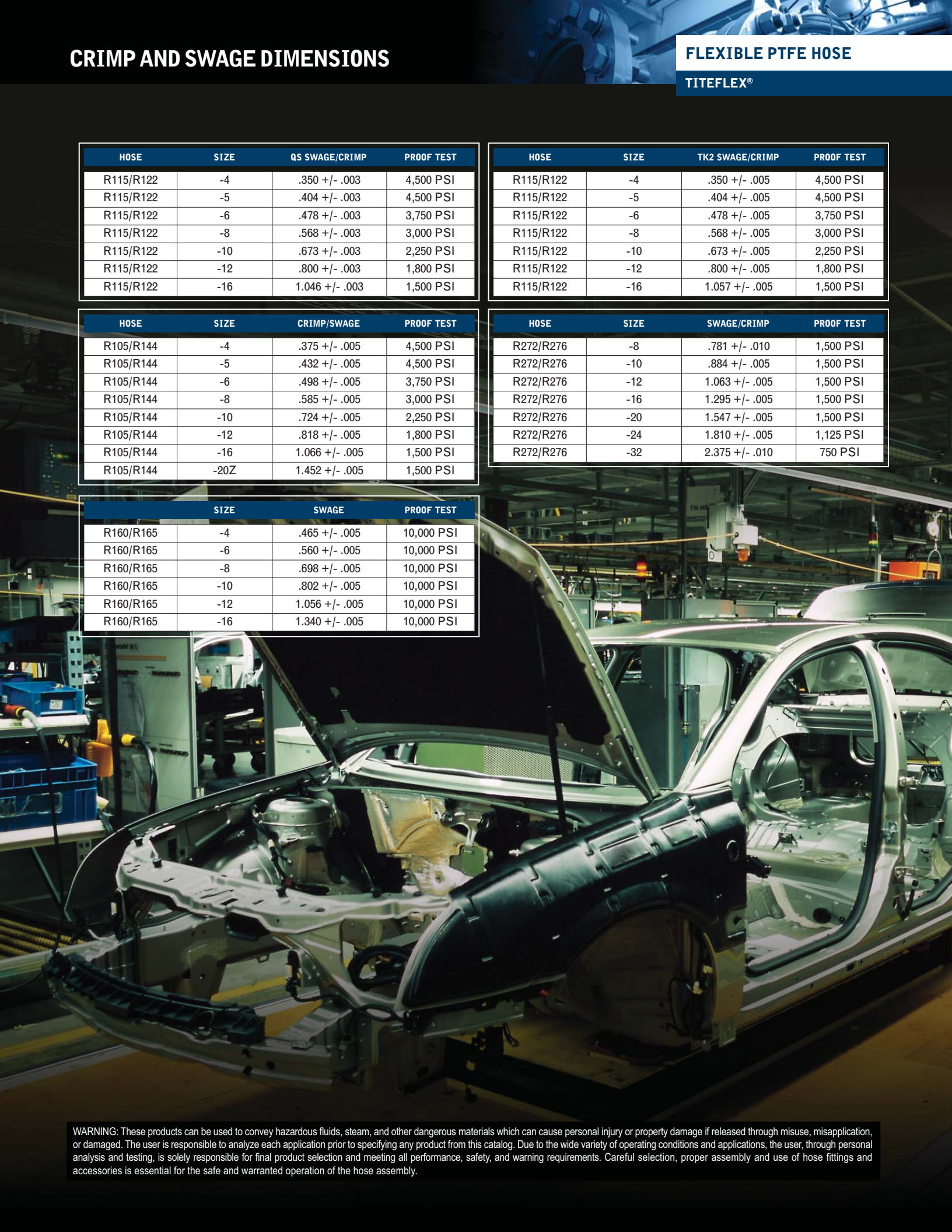

WARNING: These products can be used to convey hazardous fluids, steam, and other dangerous materials which can cause personal injury or property damage if released through misuse, misapplication, or damaged. The user is responsible to analyze each application prior to specifying any product from this catalog. Due to the wide variety of operating conditions and applications, the user, through personal analysis and testing, is solely responsible for final product selection and meeting all performance, safety, and warning requirements. Careful selection, proper assembly and use of hose fittings and accessories is essential for the safe and warranted operation of the hose assembly.

ADVANTAGES OF PTFE:

- Chemically Inert - PTFE creates a virtually universal hose which handles the broadest range of media and will not break down or deteriorate in service.
- Temperature Resistant – From cryogenics to steam all in one hose.
- Low Friction – Low pressure drop because deposits do not accumulate on the innercore. Easy to clean permitting use of one hose for several services.
- Flexible – Withstands continuous flexing and vibration while resisting failure from flex fatigue.
- Moisture Resistant – Ideal for pneumatic systems requiring low dew point functionality.
- Non-Aging – Unlimited shelf life because properties do not change with age or exposure to weather.

Titeflex hoses feature PTFE or equivalent resin which provides the following physical characteristics:

- Tensile strength 3,500 psi
- Elongation 250% min
- Dielectric strength 1,000 volts per mil
- Softening point 500°F (260°C)

PTFE FLUOROCARBON AS A HOSE MATERIAL:

Polytetrafluoroethylene (PTFE) is an engineered fluoropolymer. Outstanding resistance to chemicals is one of its primary attributes.

A broad temperature range of -65° F to 500° F (-54° C to 160° C) make this hose material suitable for the majority of fluid and ambient temperature conditions found in industry. An extremely low coefficient of friction (0.05 to 0.20) provides a non-stick surface. Water absorption of PTFE is negligible, less than 0.01% by ASTM test. And, it is FDA-approved for food and pharmaceutical use.

TYPICAL TITFLEX HOSE APPLICATIONS :

Titeflex hoses are used throughout industry for process, transfer and hydraulic and pneumatic uses. Applications typically require longer service life and excellent reliability and dependability; they include:

- | | |
|-------------------------|------------------|
| Autoclaves | Molten Plastics |
| Automotive | Packaging |
| Buses | Paints |
| Chemicals | Pharmaceuticals |
| Chlorine | Power Generation |
| CNG | Pulp & Paper |
| Compressed Gas | Pumps |
| Dehydrators | Reverse Osmosis |
| Engines | R.I.M. |
| Food Processing | Steam |
| Ground Support/Test | Steel/Aluminum |
| High Performance Racing | Textiles |
| Hot Melt | Tire Presses |
| Hot Presses | Trucks |
| Machinery | Turbines |
| Medical | Waterblast |

EXAMPLES:

1. Steam hose. Convoluted hose assemblies (R276-20) handling steam and water alternately with a 12-15 minute thermal cycle on a hot press for lamination of thermoplastics materials.
2. Chlorine transfer hose. (S81816) Loading service conditions at about -70°F (-57°C) at psi's ranging from 70 to 135. These hoses replaced Monel metal hoses.
3. Air, fuel & oil hoses in buses. Of the many applications on a bus the majority are PTFE hose assemblies (R115 hose assemblies). Temperatures to 250°F and pressures to 450 psi.
4. Turbo machinery. Lube, oil, fuel, air and coolant, transfer lines.
5. Chlorine "repackaging". Titeflex S81808 (1/2") chlorine hose has been recommended by the Chlorine Institute as a replacement for copper tubing in filling chlorine cylinders because of its safety and versatility.
6. Gasses. Medium, high and extra high pressure assemblies for transfer of compressed gasses.

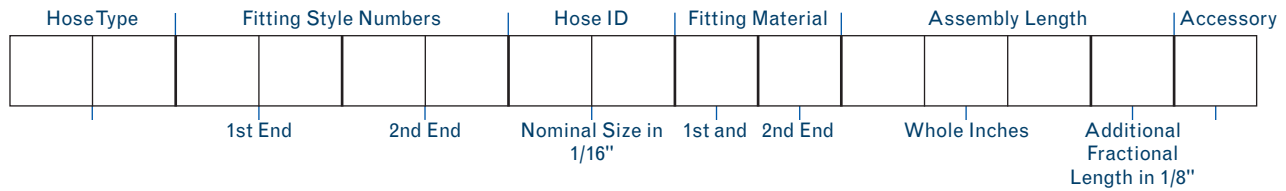

HOSE TYPE:

FR115	CZR287	DR122
AR101	CTR267	PARP101
JR154	CNR270	PERP160
CCR272	CWR273	GR105
CKR276	CFR283	HR144
CVR285	KR165	

STYLE NUMBER:

00 JIC-Female Swivel	23 Female Swivel-90° Elbow-Flareless
01 JIC-Female Swivel-45° Elbow	24 Tube Adapter
02 JIC-Female Swivel-90° Elbow	25 Butt Weld End
03 Male Pipe	26 Paint Spray Female
04 Male Union	27 Lap Joint Flange (300# Carbon Steel)
05 Fixed Flange	28 Lap Joint Flange (150# SS 304)
06 Lap Joint Flange (150# Carbon Steel)	29 Lap Joint Flange (300# SS 304)
07 SAE-Female Swivel-Straight	30 Lap Joint Flange (150# SS 316)
08 SAE-Female Swivel-45° Elbow	31 Lap Joint Flange (300# SS 316)
09 SAE-Female Swivel-90° Elbow	32 Sanitary
10 Female Pipe	33 O-Ring Face Seal
19 SAE Compression-Male	34 Cam and Groove
20 SAE Compression-Female	35 JIC Titecrimp
21 Female Swivel-Straight-Flareless	36 Male Pipe Titecrimp
22 Female Swivel-45° Elbow-Flareless	

ACCESSORY CODES:

E Chafe Sleeve-Heat-Shrinkable PTFE FEP	G Spring Guard
P Chafe Sleeve-Heat Shrinkable Polyolefin	T Halar Coating on Flange-Retaining Insert
L Hypalon Sleeve	H Halar Encapsulating of Flange-Retaining Insert
J Armor Sleeve	D Step-Down Fitting
F Fire Sleeve	S HDPE Spiral Wrap

Most accessories are designated by adding the appropriate suffix to the assembly number, as indicated. Where one of these letter codes is used, it implies that the accessory is to be applied to the entire hose length, if applicable. Certain accessories, however, are often used in short sections for strain relief or chafing protection. They include armor sleeves, heat-shrinkable chafe sleeves and spring guard.

For less than full length sections of such accessories, omit the letter code for that accessory from the assembly number and add written instructions. Indicate the accessory by specific part number, the length required, and the proper position(s) on the assembly.

Not all accessories can be used in all circumstances. Please be sure to carefully evaluate the product being transferred and its potential impact. This is the user's responsibility.

ACCESSORY PART NUMBERS:

Armor Sleeve - 106479-Size
Heat-Shrinkable Polyolefin Sleeve - 95033-Size
Heat-Shrinkable PTFE FEP Sleeve - 95423-Size
Spring Guard - Y171 (ID Size in 1/16")-1

OTHER CONSIDERATIONS

MARKINGS:

Ordinarily, Titeflex hose assemblies are not identified, except S818XX Chlorine/Bromine Transfer Hose which has markings.

We have full capability for marking assemblies with the hose number or fabrication date, your assembly number, working pressure or other pertinent information. Markings can be electroetched on fittings or on stainless steel tags which are permanently affixed.

PRESSURE TESTING:

Titeflex hose assemblies are proof-pressure-tested at 1-1/2 times the recommended operating pressure or to customer requirements. Test medium is water.

Many special testing procedures can be utilized, according to your needs, and test media can be varied on order. At the Titeflex plant, we can test with nitrogen and other gases to specific levels of pressure.

PACKAGING:

Titeflex hose assemblies are carefully wrapped and packed for shipment, with protection routinely provided for external threads of fittings and for hose lengths, to prevent kinking in transit.

CLEANING:

After fabrication, various cleaning procedures are available depending on customer requirements.

© Copyright 2011, Titeflex®. All rights reserved.

All materials and content, including but not limited to images, text, and forms contained in this catalog, are the intellectual property of Titeflex and may not be copied, reproduced, distributed, displayed, or transmitted electronically without Titeflex's express written permission.

Titeflex does not warrant, either expressly or implied, the accuracy, timeliness, or appropriateness of the content errors, omissions, or infringing material and disclaims any responsibility associated with relying on the information provided in this catalog.

TITEFLEX WARRANTY

Titeflex warrants its products to be free from any defects of workmanship in material. Should any such defects be discovered within three (3) months from the date of purchase by the end user, the questionable part should be returned to the authorized Titeflex distributor. If, upon inspection, the part proves to be defective, the authorized Titeflex distributor will furnish a replacement, or, at its option, repair the part.

This warranty shall not apply to any part or parts of hose products if it has been installed, altered, repaired or misused, through negligence or otherwise, in any way that in the opinion of Titeflex affects the reliability of, or detracts from, the performance of the product. Nor does this warranty cover replacements or repairs necessitated by loss or damage resulting from any cause beyond the control of Titeflex, including but not limited to acts of God, acts of Government, floods and fires. In case of hose assemblies fabricated by persons other than Titeflex, this warranty shall be void if the assembly is not made in accordance with Titeflex specifications or contains components which were not manufactured by Titeflex.

The obligation of Titeflex and/or its authorized distributor under this warranty is limited to making a replacement part available or the repair of the defective part, and does not include the furnishings of any labor involved or connected therewith, such as that required to diagnose trouble or to remove or install any such product, nor does it include responsibility for any transportation expenses or any damages or losses incurred in transportation in connection therewith.

This warranty is in lieu of all other warranties, express or implied. Titeflex EXPRESSLY DISCLAIMS ALL OTHER WARRANTIES, EXPRESS OR IMPLIED, INCLUDING BUT NOT LIMITED TO THE IMPLIED WARRANTIES OF MERCHANTABILITY AND FITNESS FOR A PARTICULAR PURPOSE. In no event will Titeflex be responsible for damages or losses of any nature whatsoever, including direct, indirect, consequential or incidental damages, resulting from the use of or reliance upon information herein or the products to which the information refers. Titeflex neither assumes nor authorizes any distributor or any person to assume for Titeflex any liability in connection with the sale of its products.

DISCLAIMER

Disclaimer: Although the information provided herein is presented in good faith and believed to be correct, Titeflex makes no representations or warranties as to the completeness or accuracy of the information. The recommendations and suggestions regarding product application and use that are offered by Titeflex on its website, in our product brochures, or information provided by any employee or distributor of Titeflex are only a guide in the use of our products and are not a guarantee of their performance since Titeflex has no control over the use to which other parties may apply the product.

THE INFORMATION HEREIN AND THE PRODUCTS AVAILABLE ARE PROVIDED ON AN "AS IS" BASIS. NO REPRESENTATIONS OR WARRANTIES, EITHER EXPRESS OR IMPLIED, OF MERCHANTABILITY, FITNESS FOR A PARTICULAR PURPOSE OR OF ANY OTHER NATURE ARE MADE HEREUNDER WITH RESPECT TO INFORMATION OR THE PRODUCTS TO WHICH INFORMATION REFERS.

Information is supplied upon the condition that the persons receiving same will make their own determination as to its suitability for their purposes prior to use. In no event will Titeflex be responsible for damages of any nature whatsoever resulting from the use of or reliance upon information herein or the products to which the information refers.

Any and all photographs contained herein and meant for illustrative purposes only and do not imply the appropriateness of use in any particular application.



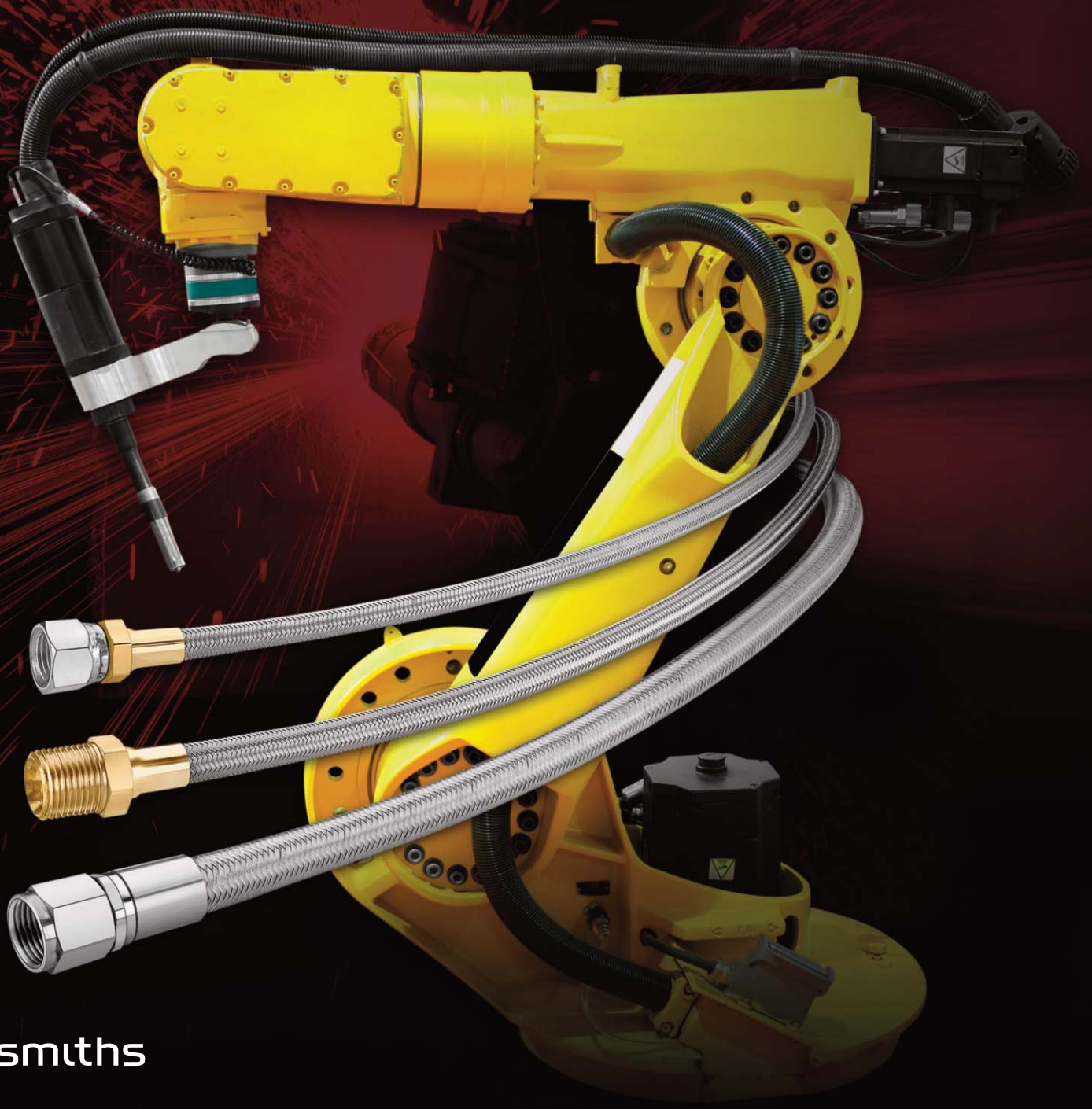

smths



			ISO 9001 REGISTERED	
--	--	--	---------------------	--